



ENAPART



93 S Railroad Avenue Unit C
Bergenfield NJ 07621 USA
www.enapart.com
sales@enapart.com



Via del Canneto 35,
Borgosatollo, Brescia - Italia
www.enapart.it
vendite@enapart.it



Barbaros Mah. Ihlamur Bul. Aĝaoĝlu
My Newwork No:3/15 Ataşehir / İstanbul
www.enapart.net
satis@enapart.net



PRIVADA 10 B SUR #3908 COL.
ANZUREZ, C.P. 72530, PUEBLA, PUE
www.enapart.com.mx
sales@enapart.com.mx



Friedrich-Ebert-Anlage 36, 60325
Frankfurt am Main, Germany
www.enapart.de
anfrage@enapart.de



4 boulevard Carnot, 95400
villiers-le-bel, Paris, France
www.enapart.fr
sales@enapart.fr



65049, ОДЕСА, ВУЛИЦЯ ІВАНА
ФРАНКА, БУДИНОК 55, ПОВЕРХ 3
www.enapart.com.ua
sales@enapart.com.ua



MUNICIPIUL BUCUREȘTI, SECTOR 3,
B-DUL BASARABIA, NR.250, CORP P+5
www.enapart.ro
sales@enapart.ro



〒584-0023 大阪府富田林市若松町
東2丁目2番16号
www.enapart.co.jp
sales@enapart.co.jp



PLAZA NUESTRA SEÑORA DE LAS
NIEVES 12 ,LOCAL ,50012,ZARAGOZA
www.enapart.es
ventas@enapart.es



Складова база „Онгъл“, Склад А2, п.к.
4006, гр. Пловдив, България
www.enapart.bg
sales@enapart.bg



3 Austin Mews, High Street, Hemel
Hempstead, HP1 3AF , United Kingdom
www.enapart.co.uk
sales@enapart.co.uk

JUMO STB/STW

Safety temperature limiter, Safety temperature monitor as per DIN EN 14597

Brief description

The safety temperature limiter (**STB**) and the safety temperature monitor (**STW**) are used to reliably detect and avert hazards that could cause injuries, are harmful to the environment or cause destruction of production plants and produced goods at an early stage. Its primary task is to reliably monitor thermal processes and switch the systems to an operational safe status in the event of malfunctions.

The measured value at the analog input can be recorded by various probes or standard signals. The exceedance of the limit value is indicated by the installed LEDs K1 and K2 (red) for each channel, and the installed relay output alarm switches the system to an operational safe status (**alarm range**).

The high standards of the DIN EN 61508 and DIN EN ISO 13849 are met by a device design, the 1oo2D structure (2-channel structure with diagnosis channel) of which ensures reliable detection of errors and, thus, can also be used for applications as per the new machinery directive 2006/42/EC.

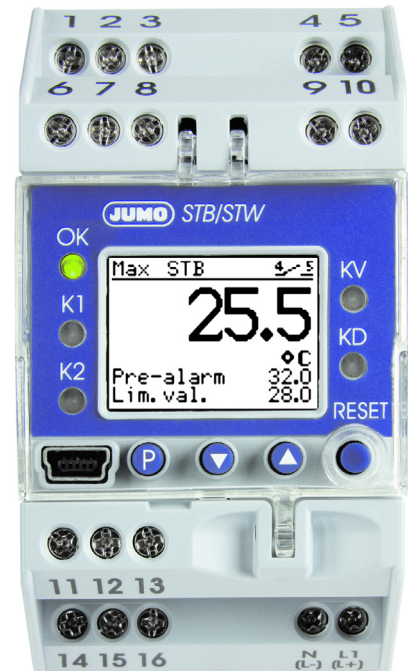

Type 701150/ ...

Block diagram

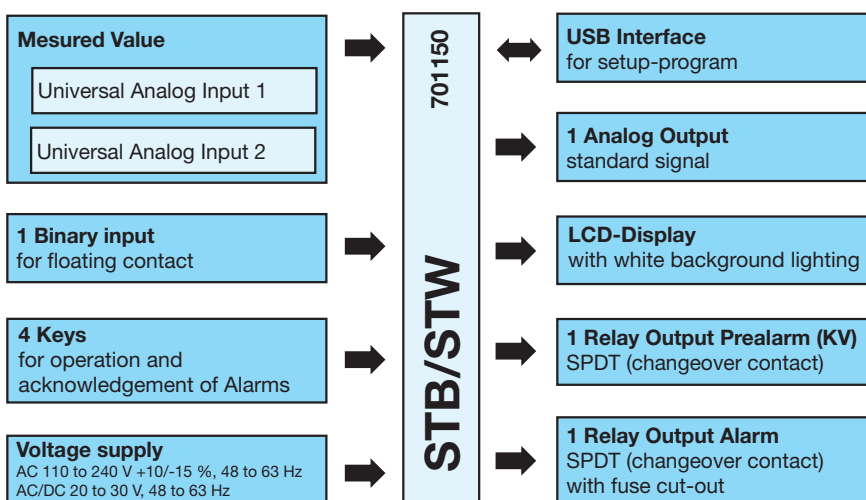

Special features

- 1oo2D structure for a high degree of process safety and reliability
- LC display with background lighting and plain text display for simplified operation
- Setup program for configuration and archiving via USB interface
- Digital input filter with adjustable filter time constant
- Pre-alarm absolute or adjustable as a margin from the limit value
- Large voltage supply range of AC 110 to 240V +10% /-15% or AC/DC 20 to 30V
- Can be configured as STB or STW
- 12 linearizations can be set
- Internal and external unlocking possible
- Approvals for DIN EN 14597, SIL, PL (Performance Level),
- Applied for UL, GL approvals

Approval/approval marks (see Technical Data)



Technical data

Analog inputs

RTD temperature probe

Designation	Measuring range	Accuracy 2/3-wire circuit ¹	Ambient temperature error
Pt 100 DIN EN 60751	-200 to +850 °C	0.5% / 0.1%	50 ppm
Pt 1000 DIN EN 60751	-200 to +850 °C	0.5% / 0.1%	50 ppm
Connection type	2-wire, 3-wire circuit	Maximum output resistance 30 Ω	
Measuring rate	210 ms		
Error tolerance time	≤ 5s time taken into account for all diagnosis tests		
Input filter	digital filter, 2nd priority; filter constant can be set from 0 to 100 s		
Special features	Individual probe Pt100 2-wire, display can also be programmed in °F		

Thermocouples

Designation	Measuring range	Accuracy ¹	Ambient temperature error
Fe-CuNi „L“ DIN 43710	-200 to +900 °C	0.4%	100 ppm
Fe-CuNi „J“ DIN EN 60584	-200 to +1200 °C	0.4%	100 ppm
Cu-CuNi „U“ DIN 43710	-200 to +600 °C	0.4%	100 ppm
Cu-CuNi „T“ DIN EN 60584	-200 to +400 °C	0.4%	100 ppm
NiCr-Ni „K“ DIN EN 60584	-200 to +1372 °C	0.4%	100 ppm
NiCrSi-NiSi „N“ DIN EN 60584	-100 to +1300 °C	0.4%	100 ppm
Pt10Rh-Pt „S“ DIN EN 60584	0 to +1768 °C	0.4%	100 ppm
Pt13Rh-Pt „R“ DIN EN 60584	0 to +1768 °C	0.4%	100 ppm
Pt30Rh-Pt6Rh „B“ DIN EN 60584	300 to 1820 °C	0.4%	100 ppm
W3Re-W25Re „D“	0 ... 2495 °C	0.4%	100 ppm
Cold junction	Pt 100 internal		
Cold junction accuracy	± 1 K		
Measuring rate	210 ms		
Error tolerance time	≤ 5s time taken into account for all diagnosis tests		
Input filter	digital filter, 2st priority; filter constant can be set from 0 to 100 s		

1. The accuracy values refer to the maximum measuring range.

Direct current

Measuring range	Accuracy	Ambient temperature error
4 to 20 mA, voltage drop < 2 V	0.2%	150 ppm
Scaling	can be freely programmed within the limits	
Measuring rate	210 ms	
Error tolerance time	≤ 5s time taken into account for all diagnosis tests	
Input filter	digital filter, 2st priority; filter constant can be set from 0 to 100 s	
Special features	Individual probe 4 to 20mA	

Analog output

	Type of signal	Accuracy	Residual ripple	Load influence	Temperature error	Load resistance
Current	4 ... 20 mA	≤ 0.5 %	± 0.5 % bei 300 Ω	± 0.05 mA/100Ω	150 ppm / °C	≤ 500 Ω
	0 ... 20 mA					
Voltage	2 ... 10 V	≤ 0.5 %	± 0.5 %	± 15 mV	150 ppm / °C	± 500 Ω
	0 ... 10 V					

Binary input

Connections	Function
1 potential-free contact	Unlocking, keyboard locking, level locking can be configured

Relay outputs

Relay output KV	Relay (change-over contact) without shroud 30,000 operations at a performance of 3 A /250 V, 50 Hz resistive load
Relay output alarm	Change-over contact Contact protection switching: safety fuse 3.15AT, installed in the NO contact arm 30,000 operations at a performance of 3 A /230 V, 50 Hz resistive load

Measuring circuit monitoring

	RTD temperature probe in 3-wire circuit and double thermocouples	Thermocouples	Current 4 to 20mA
Overrange and underrange	is detected LED K1, K2, KD and KV are lit; ">>>>" flashes in the display for overrange, "<<<<" for underrange.		
Probe and wire break	is detected LED K1, K2, KD and KV are lit; ">>>>" flashes in the display; relay output alarm is inactive		LED K1, K2, KD and KV are lit; ">>>>" flashes in the display; relay output alarm is inactive
Probe short-circuit	is detected LED K1, K2, KD and KV are lit; "<<<<" flashes in the display; relay output alarm is inactive	is detected by difference monitoring of the analog inputs	LED K1, K2, KD and KV are lit; "<<<<" flashes in the display; relay output alarm is inactive

Voltage supply

Voltage supply	AC/DC 20 to 30V, 48 to 63 Hz, AC 110 to 240V +10% /-15%, 48 to 63Hz
Power consumption	< 12 VA

Test voltages as per EN 60730, part 1

Input and output against voltage supply	
- at a voltage supply AC 110 to 240V +10% /-15%	3.7kV/50 Hz
- at a voltage supply AC/DC 20 to 30 V, 48 to 63 Hz	3.7kV/50 Hz

Electrical safety

	Clearances / creep paths
Mains to electronic components and probes	± 6 mm / ± 8 mm
Mains to relays	± 6 mm / ≥ 8 mm
Relays to electronic components and probes	± 6 mm / ≥ 8 mm
Electrical safety	as per DIN EN 14597 (DIN EN 60730-2-9) Overvoltage category III, pollution degree 2
Protection rating I	with internal separation from SELV current circuits

Environmental influences

Ambient temperature range	0 ... +55°C
Storage temperature range	-30 ... +70°C
Temperature error	$\leq \pm 0.005 \% / K$ dev. from 23 °C ¹ for RTD temperature probes $\leq \pm 0.01 \% / K$ dev. from 23 °C ¹ for thermocouples, current
Environmental performance	85 % rel. humidity without condensation (3K3 with extended temperature range as per DIN EN 60721-3-3)
EMC	as per DIN EN 14597 and standards from the standard series DIN EN 61326
Emitted interference	Class B
Interference resistance	Evaluation criteria FS as per DIN EN 14597, regulation and control devices (RS)

¹ All specifications refer to the measuring range limit value

Housing

Material	Polycarbonate
Flammability class	UL 94 V0
Electrical connection	on the front via screw terminals up to max. 2.5 mm ²
Installation	on 35 mm DIN rail as per EN 60715
Installation position	any
Weight	approx. 230g
Protection class	IP 20 to EN 60529

Approvals/Approval marks

Approval marks	Inspection authority	Certificates/certification numbers	Inspection basics	valid for
DIN	DIN CERTCO	STB/STW1223	DIN EN 14597	all device versions:
SIL2, SIL3	TÜV Nord (German Technical Inspection Agency)	SAS-0190/2006 V1.0	DIN EN 61508	all device versions:
PL d			DIN EN ISO 13849	all device versions:
c UL us	Underwriters Laboratories	-	Applied for UL 60730-2-9	all device versions:
GL	Germanischer Lloyd	-	applied for	all device versions:
Pressure equipment directive		-	applied for	all device versions:

Display and control elements

Legend	Remark	
3	LCD display black/white with background lighting 96 x 64 pixels	
6	LED KV (yellow) Is lit, if the pre-alarm was triggered.	
7	LED KD (yellow) Is lit, if the diagnosis processor has switched off a component.	
8	Keys (can only be operated when the transparent hood is folded up) ▲ Increase value, ▼ Decrease value P Programming ● RESET	
12	Setup interface	
13	LED K2 (red) Is always simultaneously lit with K1 when errors occurred on analog input 1 or 2 or in the event of overrange.	
14	LED K1 (red) Is always simultaneously lit with K2 when errors occurred on analog input 1 or 2 or in the event of overrange.	
15	LED OK green: Good range OFF: Error occurred	

Electrical isolation

(1) Analog inputs (3) Binary input (5) Set-up interface (6) Display (7) Analog output (8) Power supply		(2) Relay output alarm (4) Relay output pre-alarm
---	--	--

Switching behavior Max-Alarm (ex-factory)

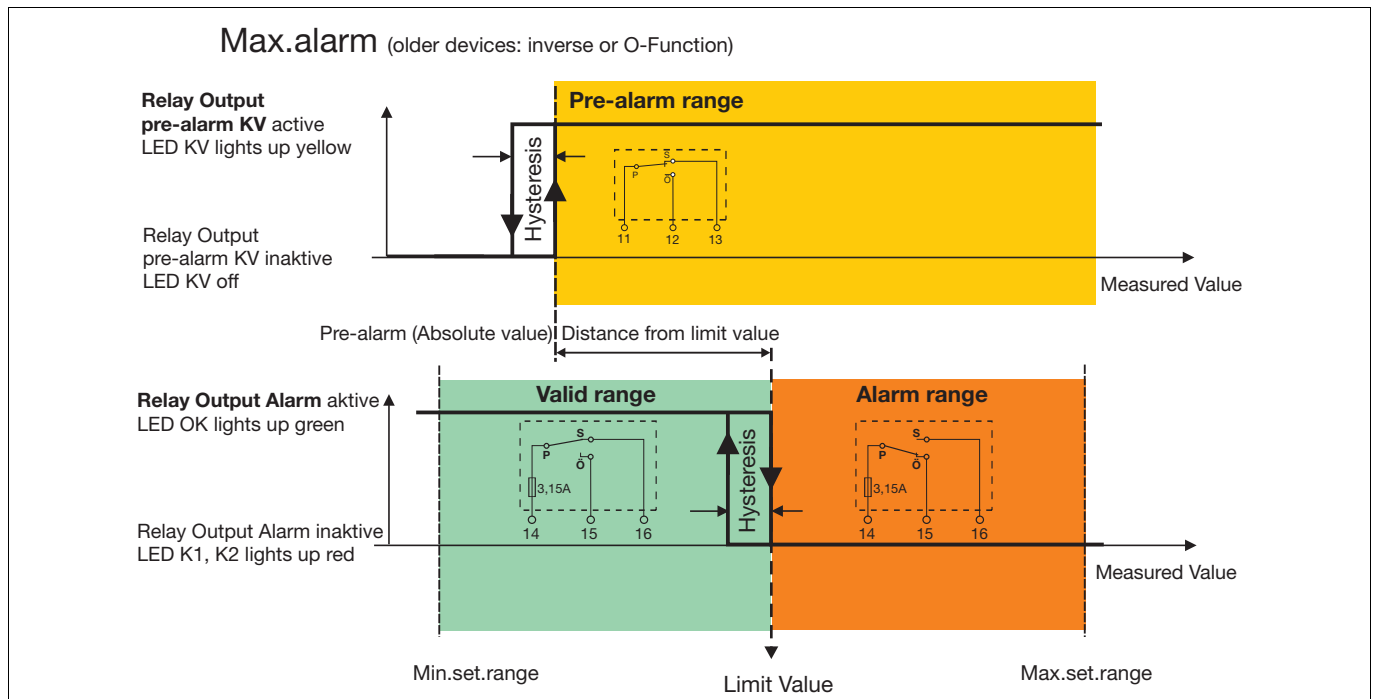

Switching behavior Min-Alarm

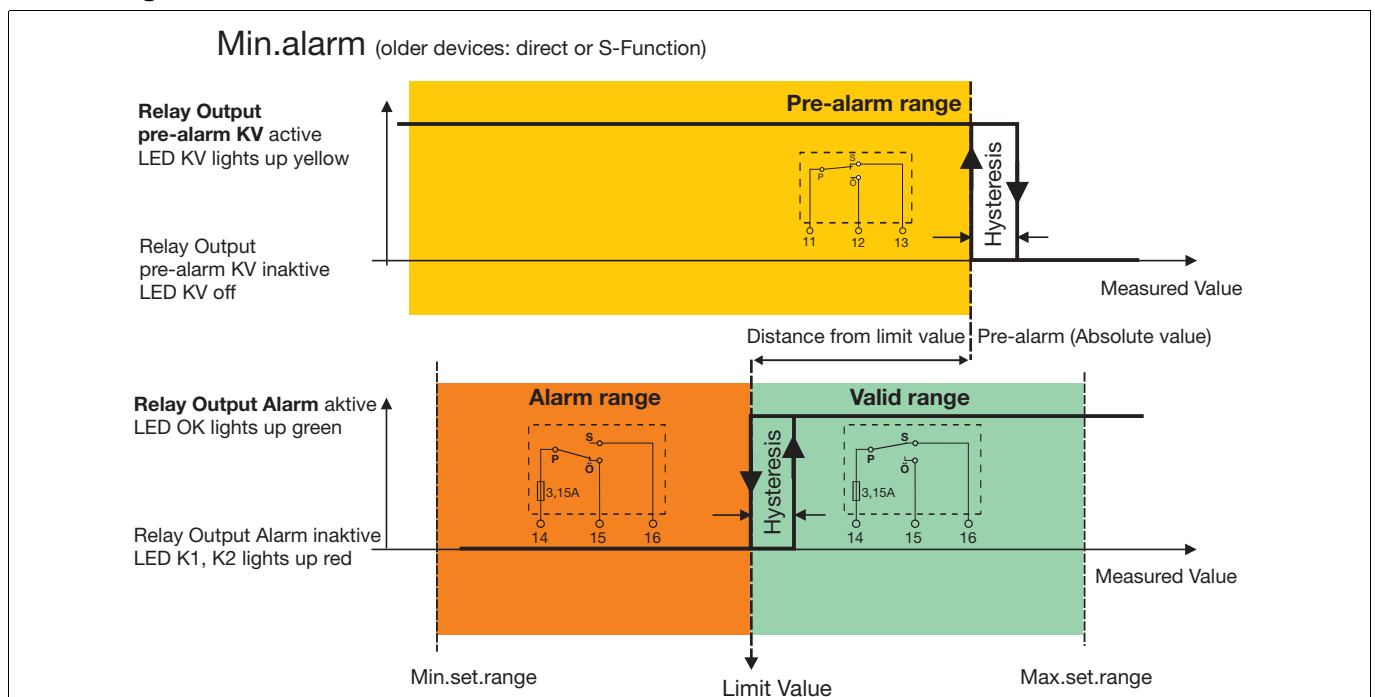





Connection diagram

The connection diagram contained in the data sheet provides preliminary information about the connection possibilities. For electrical connection, only use the installation instructions or the operating manual. The knowledge and the correct technical execution of the safety information/instructions contained in these documents are a prerequisite for installation, electrical connection and commissioning/start-up as well as for safety during operation.

<p>Connection is carried out via screw terminals.</p>	Lead	Admissible cross section
	1 wire	≤ 2.5 mm ²
	fine-strand, with core-end ferrule	≤ 1.5 mm ²

Legend	Remark	Screw terminals	Screw terminals
1, 2		Analog input 1	Analog input 2
	Thermocouple/ Double thermocouple		
	RTD temperature probe in 2-wire circuit		
	<p>👉 Enter the lead resistance for RTD temperature probes in 2-wire circuit when using greater line lengths. Setup program: <i>edit => analog inputs</i></p>		
	RTD temperature probe Pt100/Pt1000 in 3-wire circuit		
	<p>RTD temperature probe Pt100 in 2-wire circuit, individual sensor for both analog inputs</p> <p>Caution: When only one probe (SIL2) is connected, the temperature limitation device is reduced from SIL3 to SIL2! However, the internal 2-channel structure (1oo2D) in the device is still retained. Both channels measure the same sensor due to the simplified external circuit.</p>		
	(4) ... 20 mA		
	(4) ... 20 mA for both analog inputs		
	<p>Caution: When only one probe (SIL2) is connected, the temperature limitation device is reduced from SIL3 to SIL2! However, the internal 2-channel structure (1oo2D) in the device is still retained. Both channels measure the same current signal due to the simplified external circuit.</p>		

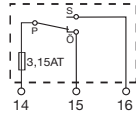
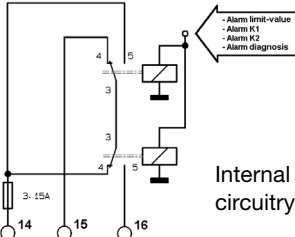
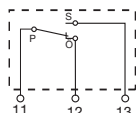
Legend	Remark	Screw terminals	Screw terminals
4	Binary input Connection to a potential-free contact		
5	Analog output: 0 ... 20 mA 4 ... 20 mA (ex-factory) 0(2) ... 10V		
9	Voltage supply as per rating plate	AC: L1 Line conductor N Neutral 	DC: (L+) (L-) 
10	Relay output alarm Relay (changeover contact element) with fuse cut-out		
11	Relay output for pre-alarm (KV) Change-over contact		

Dimensions

Type 701150/...

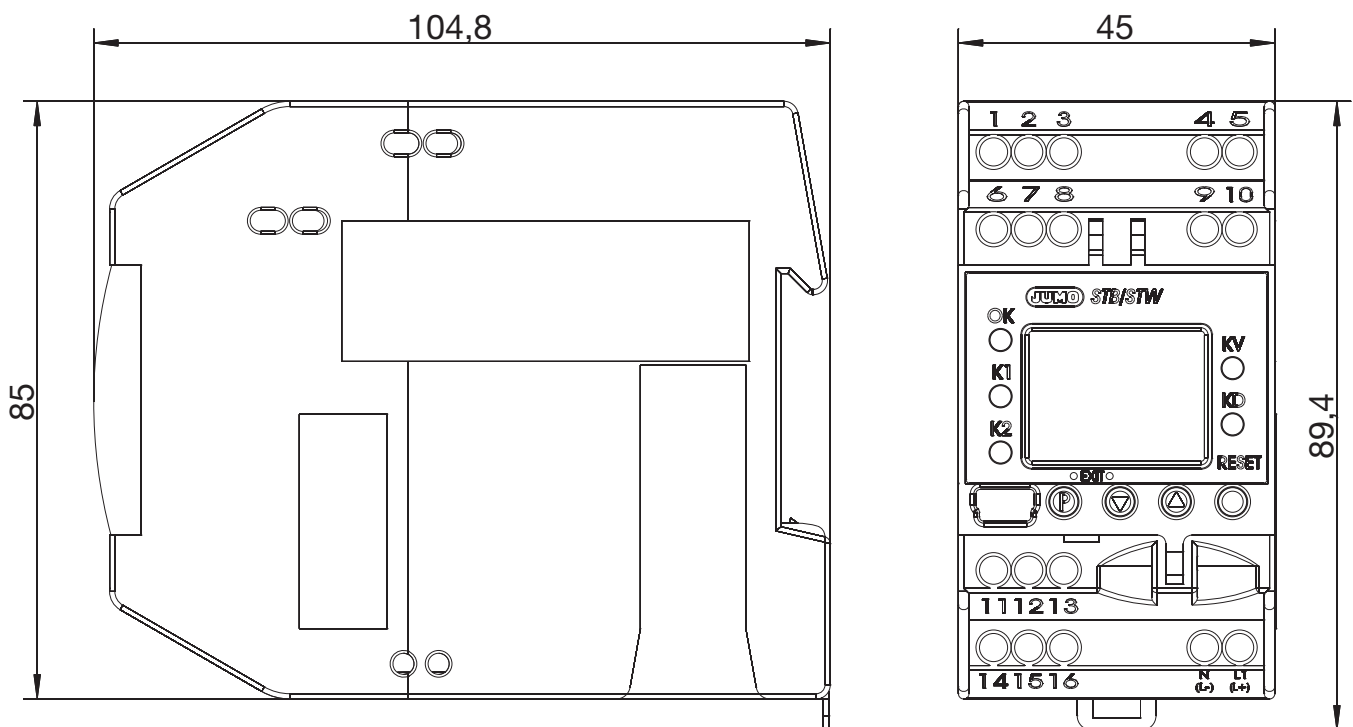

DIN-approved probes for the operating medium air (use only admissible without immersion tube)

RTD temperature probe as per Data Sheet 90.2006 actual type designation	old type designation	probe type	Temperature range	Nom. length mm	Process connection
902006/65-228-2003-1-15-500-668/000	90.271-F01	2 x Pt100	-170 ... +700°C	500	Stop flange, movable
902006/65-228-2003-1-15-710-668/000	90.272-F01			710	
902006/65-228-2003-1-15-1000-668/000	90.273-F01			1000	
902006/55-228-2003-1-15-500-254/000	-	2 x Pt100	-170 ... +700°C	500	movable G1/2 compression clamp
902006/55-228-2003-1-15-710-254/000	-			710	
902006/55-228-2003-1-15-1000-254/000	-			1000	
Thermocouples as per Data Sheet 90.1006		probe type	Temperature range	Nom. length mm	Process connection
901006/65-547-2043-15-500-668/000	90.019-F01	2 x NiCr-Ni, type K	-35 ... +800°C	500	Stop flange, movable
901006/65-547-2043-15-710-668/000	90.020-F01			710	
901006/65-547-2043-15-1000-668/000	90.021-F01			1000	
901006/65-546-2042-15-500-668/000	90.019-F11	2 x Fe-CuNi, type L	-35 ... +700°C	500	
901006/65-546-2042-15-710-668/000	90.020-F11			710	
901006/65-546-2042-15-1000-668/000	90.021-F11			1000	
901006/66-550-2043-6-500-668/000	90.023-F01	2 x NiCr-Ni, type K	-35 ... +1000°C	500	
901006/66-550-2043-6-355-668/000	90.023-F02			355	
901006/66-550-2043-6-250-668/000	90.023-F03			250	
901006/66-880-1044-6-250-668/000	90.021	1 x PT10Rh-PT, type S	0 ... 1300°C	250	
901006/66-880-1044-6-355-668/000	90.022			355	
901006/66-880-1044-6-500-668/000	90.023			500	
901006/66-880-2044-6-250-668/000	90-D-021	2 x PT10Rh-PT, type S	0 ... 1300°C	250	Stop flange, movable
901006/66-880-2044-6-355-668/000	90-D-022			355	
901006/66-880-2044-6-500-668/000	90-D-023			500	
901006/66-953-1046-6-250-668/000	90.027	1 x PT30Rh-PT6Rh, type B	600 ... 1500°C	250	
901006/66-953-1046-6-355-668/000	90.028			355	
901006/66-953-1046-6-500-668/000	90.029			500	
901006/66-953-2046-6-250-668/000	90-D-027	2 x PT30Rh-PT6Rh, type B	600 ... 1500°C	250	
901006/66-953-2046-6-355-668/000	90-D-028			355	
901006/66-953-2046-6-500-668/000	90-D-029			500	

DIN-approved probes for the operating medium water and oil (use only admissible without immersion tube)

RTD temperature probe as per Data Sheet 90.2006 actual type designation	old type designation	probe type	Temperature range	Fitting length mm	Process connection
90.2006/10-402-1003-1-9-100-104/000		1 x Pt100	-40 ... +400°C	100	G1/2 screw connection
90.2006/10-402-2003-1-9-100-104/000		2 x Pt100		100	
902006/53-507-2003-1-12-100-815/000	90.239-F02	2 x Pt100 (arranged one below the other in protection tube)	-40 ... +480 °C	100	
902006/53-507-2003-1-12-160-815/000	90.239-F12			160	
902006/53-505-2003-1-12-190-815/000	90D239-F03			190	
902006/53-507-2003-1-12-220-815/000	90.239-F22			220	
902006/54-227-2003-1-15-710-254/000	90.272-F02	2 x Pt100	-170 ... 550°C	65...670	movable G1/2 com- pression clamp
902006/54-227-1003-1-15-710-254/000	90.272-F03	1 x Pt100		65...670	
902006/10-226-1003-1-9-250-104/000	90.239	1 x Pt100	-170 ... 480°C	250	G1/2 screw connection
902006/10-226-2003-1-9-250-104/000	90-D-239	2 x Pt100		250	
902006/53-507-1003-1-12-100-815/000	90.239-F01	1 x Pt100	-40 ... +480 °C	100	Weldable sleeve
902006/53-507-1003-1-12-160-815/000	90.239-F11			160	
902006/53-507-1003-1-12-220-815/000	90.239-F21			220	
902006/53-505-1003-1-12-190-815/000	90.239-F03			190	
902006/53-505-3003-1-12-100-815/000	90.239-F07	3 x Pt100	-40 ... +400 °C	100	
902006/53-505-3003-1-12-160-815/000	90.239-F17			160	
902006/53-505-3003-1-12-220-815/000	90.239-F27			220	
902006/40-226-1003-1-12-220-815/000	90.280-F30	1 x Pt100	-170 ... +480°C	220	Weldable sleeve
902006/40-226-1003-1-12-160-815/000	90.280-F31			160	
902006/40-226-1003-1-12-100-815/000	90.280-F32			100	
Thermocouples as per Data Sheet 90.1006		probe type	Temperature range	Nom. length mm	Process connection
901006/54-544-2043-15-710-254/000	90.020-F02	2 x NiCr-Ni, type K	-35 ... 550°C	65...670	movable G1/2 com- pression clamp
901006/54-544-1043-15-710-254/000	90.020-F03	1 x NiCr-Ni, type K		65...670	
901006/54-544-2042-15-710-254/000	90.020-F12	2 x FeCuNi, type L		65...670	
901006/54-544-1042-15-710-254/000	90.020-F13	1 x FeCuNi, type L		65...670	
901006/53-543-1042-12-220-815/000	90.111-F01	1 x Fe-CuNi, type L	-35 ... 480°C	220	Weldable sleeve
901006/53-543-2042-12-220-815/000	90.111-F02	2 x Fe-CuNi, type L		220	

Safety control and regulating instruments

Safety temperature monitors STW¹

The safety temperature monitor is a device that is automatically reset when activated, once the sensor temperature has fallen below or risen above the set limit value by an amount equal to the hysteresis. Possible settings: monitoring for limit value overrange or under-range.

Mode of operation:

Minimum requirements: 2B, 2K, 2P

additionally met requirements: 2N, 2D

Safety temperature limiters STB¹

The safety temperature limiter is a device that is permanently locked after response.

Manual reset using the RESET key is possible once the probe temperature is gone below / has exceeded the limit value by the hysteresis. Possible settings: monitoring for overrange or under-range.

Mode of operation:

Minimum requirement: 2B, 2J, 2V, 2K, 2P and adjustable with special tool

additionally met requirements: 2N, 2F, 2D

¹For more detailed explanation, see DIN EN 14 597.

Connection possibilities of the sensors

The STB/STW 701150 evaluation device structure is basically identical. There are various possibilities to connect the sensors. These possibilities are listed in the following table together with the achievable SIL level:

Variant	connected sensors	Sensor system architecture	Logics architecture	Achievable SIL		
1	1 × Pt 100 in 2-wire circuit individual sensor	1oo1	1oo2D	SIL2		
2	2x Pt 100/1000	1oo2	1oo2D	SIL3		
3	2x Thermocouples	1oo2	1oo2D	SIL3		
4	1x Pt 100/1000 1x Thermocouple	1oo2	1oo2D	SIL3		
5	STB/STW 70.1150 without sensor system 1oo2D architecture no probe or use 4 to 20 mA (means: the sensor is not taken into account for calculation.)	Sensors connected by the system owner/user Architecture as per connection 1oo1 or 1oo2	1oo2D	SIL of the used sensor (HW only)	max. achievable SIL of the system with 1oo1 sensor system architecture	max. achievable SIL of the system with 1oo2 sensor system architecture
				1	1	2
				2	2	3
				3	3	3

No sensor system was taken into account for variant 5. In this case, the owner/user selects the sensor system. For this reason, the owner/user is responsible for evaluating the achievable SIL.

If the SIL compatible sensor used consists of hardware and software (e.g. transmitter), it is possible to achieve the SIL irrespective of the architecture as a maximum, once the sensor software is developed, i.e. for example, in the case of the sensor software has SIL 2, the max. achievable SIL is 2.

The possibility to connect passive sensors such as double thermocouples or PT100, Pt1000 sensors do not necessarily require a SIL qualification. In this case, the specification of the failure rates of the passive sensors is sufficient for the SIL qualification of the overall system. The owner/user of the system must always determine the PFD_{avg} and/or PFH value of the overall safety circuit to evaluate the achieved SIL.

Failure rates and SSF for 70.1150...23 (AC240V)

Vari-- ant	λ_s [Fit]	λ_{dd} [Fit]	λ_{dd} [Fit]	SSF	PFH (1/ h)	PFD _{avg}
1	917.24	278.5	89.80	93.01%	1.04 e ⁻⁸	2.59 e ⁻⁴
2	917.24	278.5	89.80	93.01%	7.47 e ⁻⁹	1.03 e ⁻⁴
3	930.69	301.37	91.74	93.07%	7.95 e ⁻⁹	1.04 e ⁻⁴
4	936.75	318.41	93.64	93.06%	8.40 e ⁻⁹	1.08 e ⁻⁴
5	930.09	291.77	89.94	93.14%	7.67 e ⁻⁹	9.97 e ⁻⁵

Failure rates and SSF for 70.1150...25 (AC/DC24V)

Vari-- ant	λ_s [Fit]	λ_{dd} [Fit]	λ_{dd} [Fit]	SSF	PFH (1/ h)	PFD _{avg}
1	851.33	278.98	90.7	92.57%	1.05 e ⁻⁸	2.60 e ⁻⁴
2	851.33	278.98	90.7	92.57%	7.53 e ⁻⁹	1.04 e ⁻⁴
3	876.32	301.85	93.48	92.65%	8.07 e ⁻⁹	1.06 e ⁻⁴
4	882.38	318.89	95.38	92.65%	8.51 e ⁻⁹	1.10 e ⁻⁴
5	868.03	300.5	91.54	92.74%	7.78 e ⁻⁹	1.02 e ⁻⁴

The PFH and PFD_{avg} values were calculated assuming that the time to restore the system is 8h (MTTR = 72h). Furthermore, the calculation was based on a lifetime of 10 years ($T_1 = 10y$). The common cause factor was determined as per the tables of the DIN EN 61508 for sensor systems and logics.

Calculations DIN EN ISO 13849-1 Performance Level PL d - Low voltage 230V

Variant	MTTF _d	DC _{avg}	CCF
1	100 years ³ (310 years)	76%	80
2	100 years ³ (310 years)	76%	80
3	100 years ³ (290 years)	77%	80
4	100 years ³ (300 years)	76%	80
5	100 years ³ (299 years)	76%	80

Calculations DIN EN ISO 13849-1 Performance Level PL d - Safety extra low voltage 24V

Variant	MTTF _d	DC _{avg}	CCF
1	100 years ³ (309 years)	75%	80
2	100 years ³ (309 years)	75%	80
3	100 years ³ (289 years)	76%	80
4	100 years ³ (299 years)	76%	80
5	100 years ³ (291 years)	77%	80

3. The MTTF_d value of a partial system must be limited to 100 years as per the DIN EN ISO 13849-1 requirements.

Order details

- (1) model**
- 701150 safety temperature limiter / monitor
- (2) configuration**
- 8 with factory settings
- 9 programming to customer spec.
- (3) language**
- 01 German
- 02 English
- 03 French
- (4) switching action**
- 0251 Safety temperature monitor (O-function)
- 0252 Safety temperature monitor (N.O.-funct.)
- 0253 Safety temperature limiter (O-function)
- 0254 Safety temperature limiter (N.O.-funct.)
- (5) measuring insert**
- 1003 1x Pt100 2-wire
- 1053 1x 4..20mA
- 2001 2x Pt100 3-wire
- 2003 2x Pt100 2-wire
- 2005 2x Pt1000 2-wire
- 2006 2x Pt1000 3-wire
- 2037 2x W3Re-W25Re "D"
- 2039 2x Cu-CuNi "T"
- 2040 2x Fe-CuNi "J"
- 2041 2x Cu-CuNi "U"
- 2042 2x Fe-CuNi "L"
- 2043 2x NiCr-Ni "K"
- 2044 2x Pt10Rh-Pt "S"
- 2045 2x Pt13Rh-Pt "R"
- 2046 2x Pt30Rh-Pt6Rh "B"
- 2048 2x NiCrSi-NiSi "N"
- 2053 2x 4..20mA
- (6) power supply**
- 23 AC 110..240V +10/-15%,48..63Hz
- 25 AC/DC 20..30V,48..63Hz
- (7) output**
- 001 0..20mA continue
- 005 4..20mA continue
- 040 0..10V analog
- 070 2..10V analog
- (8) extra code**
- 000 no approvals
- 058 with SIL and PL approval

Order code (1) (2) (3) (4) (5) (6) (7) (8)
 - - - - - - /

Scope of delivery

1 STB/STW in the version ordered
1 Operating Manual 70.1150.0

Accessories

Part	Sales number
Setup program, multilingual	70/00548742
USB cable	70/00545170
External unlocking button RT	70/97097865

Stock versions

Order code	Sales number
701150/8-01-0253-2001-23-005	70/00548736
701150/8-01-0253-2001-25-005	70/00548737